

# wide

OPERATIONS MANUAL

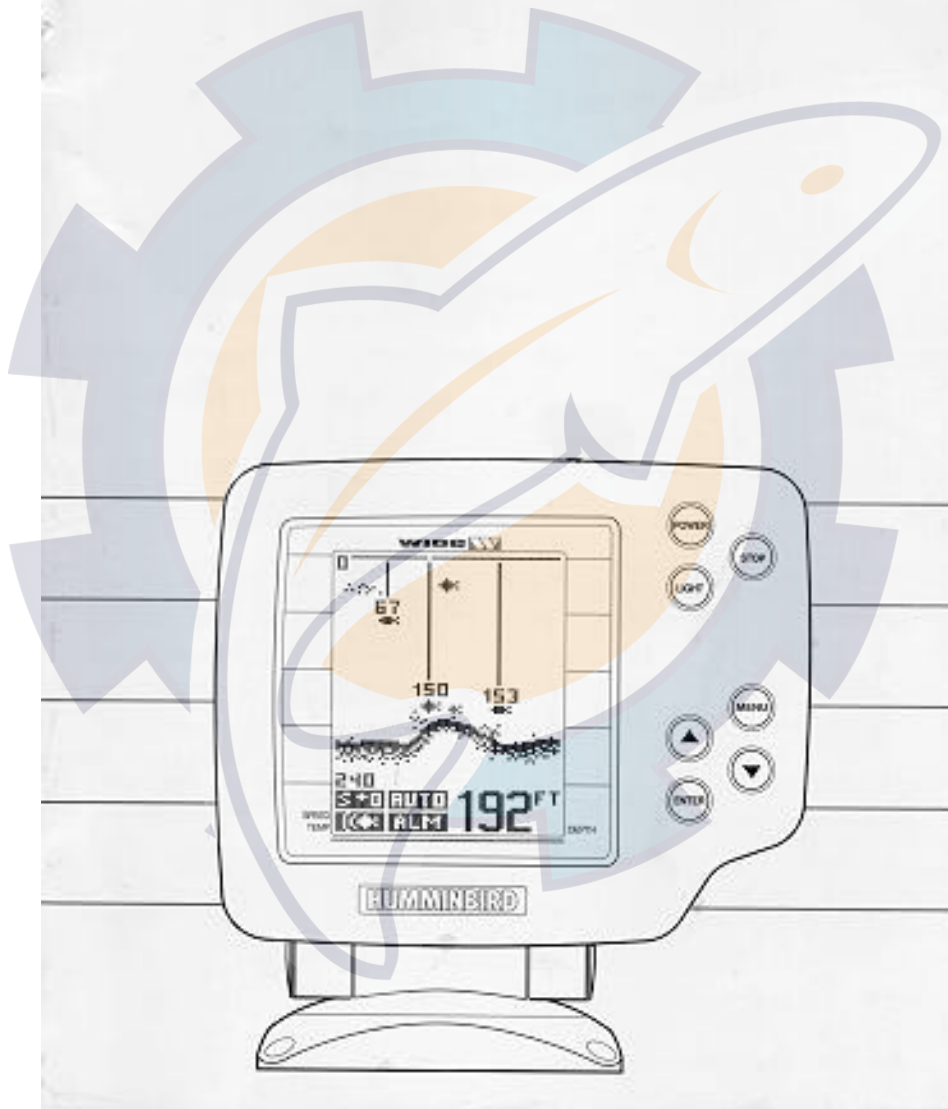

# INSTALLATION PREPARATION

## PARTS SUPPLIED

### **PARTS SUPPLIED**

Before installing your new Humminbird fishfinder, please ensure the following parts are included in the box:

- Fishfinder
- Transducer with 20' (6m) of cable and mounting hardware kit
- Mounting system and mounting hardware kit
- 6' (2m) power cable
- Publications kit

If any of these items is missing, call our Customer Support Hotline.

### **ACCESSORIES**

Humminbird offers a wide assortment of accessories that complement and expand the capability of your new fishfinder. These accessories are designed with the same high standards and are backed by the same one-year warranty. The Humminbird Accessory catalog included with your unit contains descriptions of the many accessories available and ordering information. All Humminbird accessories are available through your full-service Humminbird dealer or factory direct through our number listed in the Customer Support section.

### **INSTALLATION OVERVIEW**

Your Humminbird fishfinder consists of two primary components to install: the control head and the transducer.

The control head contains the sonar transmit and receive circuitry, as well as the user controls and display. It should be installed in a location that provides access to the controls and visibility while in use. The control head mounts on a quick disconnect mounting system that swivels and tilts providing flexibility for viewing from almost anywhere on the boat.

The transducer converts electrical energy from the transmitter into mechanical pulses or sound waves. The transducer also receives the reflected sound waves and converts them back into electrical signals for display on the control head. It should be installed in contact with the surface of the water in an area that has smooth waterflow- usually on the transom of the boat. There are several mounting options for the transducer. Review the following section to determine the method that works for you and your boat.

# INSTALLATION PREPARATION

## INSTALLATION OVERVIEW

### *Determining How to Mount the Transducer*

Your Humminbird fishfinder includes a standard transducer. This transducer can be mounted on the transom of the boat or bonded to the inside of a fiberglass hull boat.

The transom installation, which is the most widely used, places the transducer on the outside of the boat hull. This technique produces the least signal loss, and provides a way to adjust the transducer after installation. The mounting hardware included is designed to protect both the boat and the transducer should the boat strike debris in the water or when trailering.

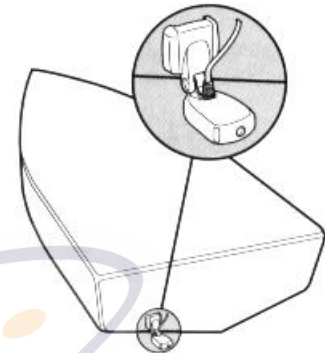

*Transom Mounted Transducer*

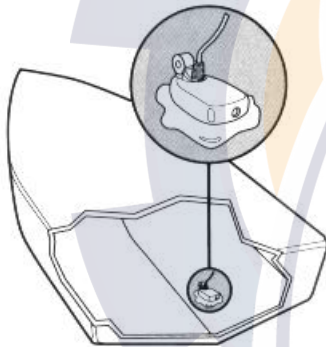

*Inside the Hull Mounted Transducer*

As an alternative to transom mounting, it is possible on many fiberglass-hulled boats to glue the transducer on the inside of the boat hull. Since fiberglass has similar sonar characteristics as water, the sonar signal can pass through the boat hull with minimal loss. The hull of the boat must be single layer construction (not double-hulled) Also, any air trapped in the lamination of the fiberglass would prevent the sonar signal from passing through.

Inside the hull installations require no holes be drilled into the boat and through experimentation, high-speed operation comparable to transom mounting can be achieved. Two-part slow cure epoxy (not included) is required to glue the transducer in place.

# INSTALLATION PREPARATION

## ALTERNATE MOUNTING METHODS

### ALTERNATE TRANSDUCERS AND MOUNTING METHODS

Your Humminbird fishfinder comes with everything necessary for installation and operation on most boats. However, there are several situations which may require a different type of transducer. Inboard boats, wood or metal hulls, and sail boats create unique transducer mounting needs. Alternate transducers and mounting methods are detailed below.

#### **Portable Mounting**

The standard transducer can be adapted for portable installations with a portable mounting kit available from Humminbird. This accessory adapts your transducer to a suction cup mount for temporary installation on the boat hull or other surface.



#### **Trolling Motor Mounting**

The standard transducer can also be adapted to mount on most trolling motors using a different accessory kit. This accessory includes a bracket and hose clamp that allows mounting the transducer to the body of most trolling motors.



#### **Thru-Hull Mounting**

Thru-hull transducers install through a hole drilled in the hull of the boat. Larger boats or boats with inboard motors create turbulence that make transom mounting ineffective. Also, hulls that are very thick or are double layered, or made from materials such as wood or metal, (which do not conduct sonar signals) make inside the hull mounting inadvisable.

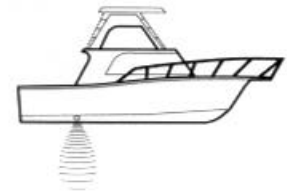

Thru-hull mounting may require the use of a fairing block to level the transducer with the waterline. Also, since special tools and knowledge may be required to perform this type of installation, it is best to refer to a qualified marine technician.

# INSTALLATION PREPARATION

## TRANSDUCER EXCHANGE

### **TRANSDUCER EXCHANGE**

Other transducers are available as replacements for the standard transducer. You may exchange your new and unassembled transducer for another type by returning it to the address listed in Customer Support. Some transducers may have additional cost. Refer to the Accessory catalog or call Customer Support for information.

### **BEGINNING INSTALLATION**

Now that you have determined the transducer mounting method you can begin installation of your new Humminbird fishfinder. The installation guide included on the next few pages provides detailed step by step instructions for installation of the control head and transducer. For transom mount transducer installations you will need the mounting template included with your manual.

In addition to the parts included you need the following for installation and operation:

- A powered hand drill and various drill bits
- Philips and flat-head screwdrivers
- A ruler or measuring tape
- Pen or pencil
- 12 volt power source (your boat's battery)
- A 1-amp fuse
- A fuse holder (if you are wiring directly to the boat's battery)
- Silicone sealant (for sealing drilled holes)
- 2-part, slow-cure epoxy (for inside the hull transducer installations)

# INSTALLATION

## TRANSOM INSTALLATION

**Do not begin this transducer installation until you read the Installation Preparation in the Operation Guide. This chapter contains information critical to the correct installation of your transducer.**

**Due to the wide variety of boat hulls, only general instructions are presented in the installation guide. Each boat hull represents a unique set of requirements that should be evaluated prior to installation.**

### TRANSOM INSTALLATION

#### Step One - Determine Where to Mount the Transducer

Begin the transducer installation by determining where on the transom to install the transducer. Consider the following to find the best location:

- It is very important to locate the transducer in an area which is relatively free of turbulent water. As a boat moves through the water, turbulence is generated by the weight of the boat, and the thrust of the propeller(s). This turbulent water is normally confined to areas immediately aft of ribs, strakes or rows of rivets on the bottom of the boat, and in the immediate area of the propeller(s) (Figure 1). On outboard or inboard/outboard boats it is best to stay at least 15" (40cm) to the side of the propeller(s).
- If possible, viewing the transom of the boat while the boat is moving will provide the best means of locating turbulence free water. If maximum high-speed operation is a high priority, this is the recommended method. If this is not possible, select a location on the transom where the hull forward of this location is smooth, flat, and free of protrusions or ribs.
- The transducer when mounted should point straight down. The design of the transducer will accommodate a wide range of deadrises and remain ported straight down (Figure 2).
- On boats with stepped hulls, it may be possible to mount the transducer on the step. Never mount the transducer on the transom behind a step, as this area of the transom will not be in contact with the water at high speed (Figure 3).

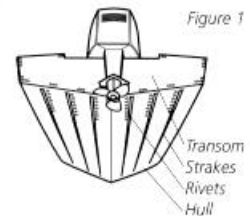

Transom Mounting Location

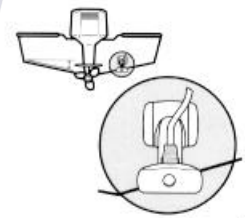

Figure 2

Stepped Hull

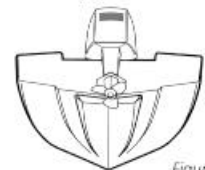

Figure 3

# INSTALLATION

## TRANSOM INSTALLATION

- If the propeller(s) is (are) forward of the transom, it may be impossible to find an area clear from turbulence, and a different mounting technique or transducer type should be considered.

### Step Two - Drill the Mounting Holes

1. Remove the mounting template from the front of the Operations Manual.
2. Hold the template on the transom of the boat in the location where the transducer will be installed (Figure 4). Align the template vertically, ensuring the lower edge of the transom meets with the bottom corner of the template.
3. Using a pencil or punch, mark the two mounting holes shown on the template onto the transom. Do not mark or drill any other holes at this time.
4. Using a 5/32" (4mm) bit drill the two holes to a depth of approximately 1" (3cm). On fiberglass hulls, it is best to start with a smaller bit and use progressively larger drill bits to reduce the chance of chipping or flaking the outer coating.

Template alignment

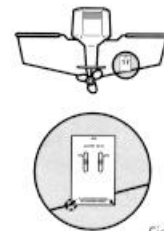

Figure 4

Transducer Assembly

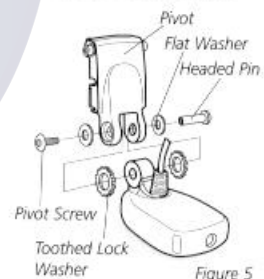

Figure 5

### Step Three - Assemble the Transducer

1. Attach the Pivot to the transducer body as shown in Figure 5, using the #8 – 3/8" (9mm) long allen headed pivot screw, the headed pin, the two flat washers, and the two toothed lock washers.

**Note: The toothed lock washers must be positioned between the transducer and the pivot ears. The flat washers must be positioned to the outside at the pivot ears.**

2. Using the Allen wrenches provided, loosely tighten the pivot screw (Figure 6). Do not completely tighten the assembly at this time, so the pivot angle can be adjusted later.
3. Insert the pivot/transducer assembly into the mounting bracket as shown in Figure 7. Do not snap the assembly closed.



Figure 6

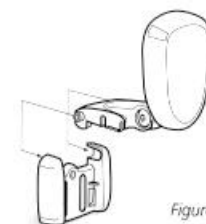

Figure 7

# INSTALLATION

## TRANSOM INSTALLATION

### Step Four - Mount the Transducer to the Transom

1. Apply silicone sealant to the mounting holes drilled into the transom.
2. Align the transducer assembly with the drilled holes in the transom (Figure 8).
3. Use either a flat head screwdriver, a 5/16" (8mm) hex driver, or a 5/16" (8mm) socket to mount the assembly. Using the two #10 – 1" (25mm) long slotted hex head screws, mount the transducer assembly to the transom as shown. Do not fully tighten the mounting screws in order to vertically adjust the transducer. Snap the pivot down into place.

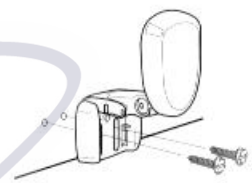

Figure 8

### Step Five - Adjust the Running Position of the Transducer

The bracket allows height and tilt adjustment, the pivot screws allow angular adjustment. Initially, adjust the transducer as described in the following paragraphs. Further adjustment may be necessary to refine the instillation after high speed testing.

1. First adjust the pivot angle of the transducer body so its length is parallel with the length of hull of the boat. Then pivot the transducer down so the rear is about 1/4 inch (6mm) lower than the front (Figure 9).
2. Fully tighten the two pivot screws using the Allen wrenches. It may be necessary to retighten the pivot screws after the initial use as the plastics may still be seating to the lock washers.
3. Adjust the height of the assembly so the face of the transducer is 3/16" (4.5mm) beneath the lower edge of the transom (Figure 10). Mark the position of the mounting bracket on the transom with a pencil.
4. Force the pivot to the up position to gain access to the mounting screws. Assure the transducer location has not changed, then fully tighten the two mounting screws (Figure 11). Snap the pivot back down.

#### Running Position Adjustment



Figure 9

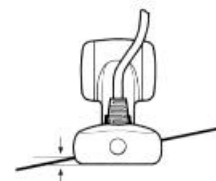

3/16" (4.5mm)

Figure 10

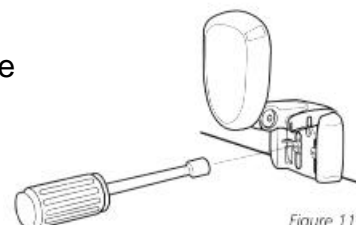

Figure 11

**Confirm the pivot angle has not changed.**

**Note: A third screw location is provided for the**



***mounting bracket. Drill this hole and install the screw after final testing and adjustments have been completed.***



# INSTALLATION

## TRANSOM INSTALLATION

### **Step Six - Route the Cable**

There are several ways to route the transducer cable to the area where the control head will be installed. The most common procedure routes the cable through the transom into the boat.

Inside the boat there is often a channel or conduit used for other wiring that the cable can be routed along. Do not cut or shorten the transducer cable and try not to damage the cable insulation. Route the cable as far as practical from the VHF radio antenna cables or tachometer cable to reduce the possibility of interference.

If the cable is too short, extension cables are available to extend the transducer cable up to a total of 50' (15 m). Call Humminbird Customer Support for more information.

Follow these steps to route the cable through the transom:

1. Drill a 5/8" (16mm) hole above the water line. Route the cable through the hole.
2. Fill the hole with silicone sealant.
3. Place the escutcheon plate over the hole and attach with the two #8 x 5/8" (16mm) screws.
4. Secure the cable by attaching the cable clamp to the transom using a #8 x 5/8" (16mm) screw.

**Note: The transducer will pivot up to 90 degrees in the bracket. Allow enough slack in the cable for this movement. It is best to route the cable to the side of the transducer so the cable will not be damaged by the transducer during movement.**

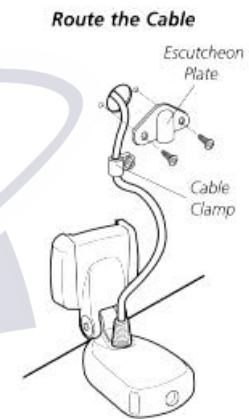

Figure 12

# INSTALLATION

## INSIDE THE HULL INSTALLATION

### INSIDE THE HULL INSTALLATION

Inside the hull installation requires the mount system and control head be installed and operational. See Installing the Control Head for instruction on installing the unit.

Inside the hull mounting generally produces good results in single thickness fiberglass-hulled boats. Humminbird cannot guarantee depth performance when transmitting and receiving through the hull of the boat since some signal loss occurs. The amount of loss depends on hull construction and thickness, and the installation.

This installation requires slow-cure two-part epoxy. Do not use silicone or any other soft adhesive to install the transducer, as this material reduces the sensitivity of the unit. Five minute epoxy has a tendency to cure before all the air bubbles can be purged.

#### Step One - Determine the Mounting Location

Begin the transducer installation by determining where inside the hull to install the transducer. Consider the following to find the best location:

- Observe the outside of the boat hull to find the areas that are mostly free from turbulent water. Avoid ribs, strakes, and other protrusions as these create turbulence (Figure 14).
- As a general rule, the faster the boat can travel the further aft and closer to the centerline of the hull the transducer has to be located to remain in contact with the water at high speeds.

#### Step Two - Test the Mounting Location

There is no opportunity for adjustment after the transducer glued in place. Therefore, it is best to perform a trial installation on inside the hull transducers first, and run the boat at high speeds to determine the best mounting area.

1. At the identified mounting location, lay the transducer body face down with the pointed end towards the bow.
2. Fill the hull with enough water to submerge the transducer body. Use a sand filled bag or other heavy object to hold the transducer in position.

Transducer Mounted Inside the Hull

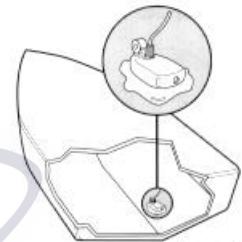
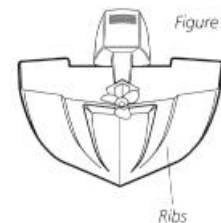

Figure 13

Figure 14



Preferred Mounting Area



Figure 15

The transducer cannot transmit through air. The water purges any air from between the transducer and the hull and fills any voids in the coarse fiberglass surface.



# INSTALLATION

## INSIDE THE HULL INSTALLATION

3. Power up the Control Head.
4. Run the boat at various speeds and water depths while observing the screen on the Control Head. If the unit functions well at low speeds but begins to skip or miss the bottom at higher speeds, the transducer needs to be moved. If depth performance is required, test the fishfinder in water at the desired depth. Test different locations in the hull until the optimum performance is achieved.

### **Step Three - Permanently Mount the Transducer**

1. Once the mounting location is determined, mark the position of the transducer.
2. Remove the water from inside the hull and thoroughly dry the mounting surface. If the surface is excessively rough, it may be necessary to sand the area to provide a smooth mounting surface.

Ensure the mounting area is clear and dry.

3. Mix an ample quantity of two-part slow-cure epoxy slowly and thoroughly. Avoid trapping air bubbles.
4. Coat the face of the transducer and the inside of the hull (Figure 16).
5. Press the transducer into place with a slight twisting motion to purge any trapped air from underneath, keeping the pointed end of the transducer body pointed forward (Figure 17).

**Note: Proper operation requires the pointed end of the transducer body to face towards the bow.**

6. Weight the transducer so it does not move while the epoxy is curing.

When the epoxy cures, no water is necessary inside the hull. Neither water, spilled gasoline, or oil will affect the performance of the transducer.

Figure 16

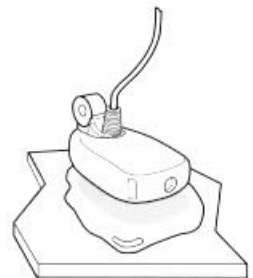
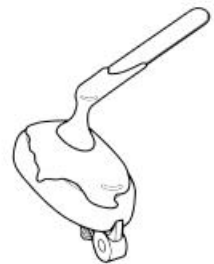

Figure 17

# INSTALLATION

## CONTROL HEAD INSTALLATION

### CONTROL HEAD INSTALLATION

#### Step One - Determine Where to Mount

Begin the installation by determining where to mount the control head. Consider the following to determine best location:

- The cables for power, transducer and temp/speed accessories (if applicable) should be installed first and must reach the mounting location. Extension cables are available.
- There are two ways to route the cables to the unit: through a hole in the mounting surface underneath the mounting bracket or from a hole outside the mounting bracket. Routing the cables down under the mount provides maximum weather protection; however this is not always feasible if the area under the fishfinder is inaccessible. In this case, route the cables through a hole at another location and cover with the supplied hole cover.
- The mounting surface should be adequately supported to protect the fishfinder from excessive wave shock and vibration, and provide visibility while in operation.
- The mounting area should allow sufficient room for the unit to pivot and swivel freely, and for easy removal and installation (Figures 18-19).

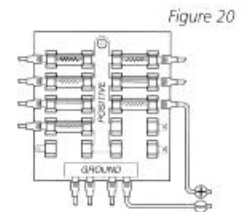
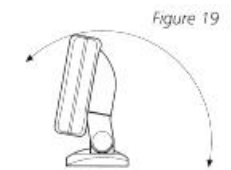
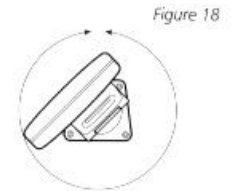

#### Step Two - Connect the Power Cable to the Boat

A 6' (2m) long power cable is included to supply power to the fishfinder. You may shorten or lengthen the cable using 18 gauge multi-stranded copper wire.

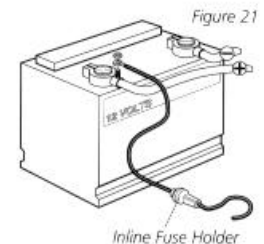

**CAUTION: Some boats have 24 or 36 volt electric systems. Be sure your unit is connected to a 12 VDC power supply.**

The Power can be connected to the boat's electrical system at two places: a fuse panel, usually located near the console, or directly to the battery.

If a fuse terminal is available, use crimp-on type electrical connectors (not included) that match the terminal on the fuse panel. Attach the black wire to ground, and the red wire to 12 VDC power (Figure 20). Be sure to use a one amp

fuse in the connection. If you must wire the control head directly to a battery, be sure to install an inline fuse holder



# INSTALLATION

## CONTROL HEAD INSTALLATION

and one amp fuse (not included) for the protection of the unit (Figure 21). Humminbird is not responsible for over voltage or over current failures.

In order to minimize the potential for interference with other marine electronics a separate power source (such as a second battery) may be necessary.

### Step Three - Drill the Mounting Holes

1. Set the mounting bracket in place on the mounting surface. Mark the four mounting screw locations with a pencil or punch.
2. Set the mounting bracket aside, and drill the four mounting screw holes using a 9/64" (3.6mm) bit.

### Step Four - Run the Cables

1. If the cables must pass through a hole underneath the mounting surface, mark and drill a 1" (25mm) hole centered between the four mounting holes (Figure 22).

**Note: if the cables must pass through the mounting surface at a different location, drill the 1" (25mm) hole at that location and pass the cables through from underneath. Also, you must break out the tabs on the rear of the mounting base using needle nose pliers (Figures 24-25).**

2. Insert all cables through the 1" (25mm) hole from beneath the mounting surface.
3. Pass the cables through the grommet (if the cable hole is underneath the mounting bracket) then press the grommet in place around the cables and into the 1" (25mm) hole.
4. Pass the cables through the mounting base, out the top of the mounting bracket.
5. Place the mounting bracket on the mounting surface aligned with the drilled holes. Insert the four flathead wood screws into the mounting holes and tighten fully (Figure 23).

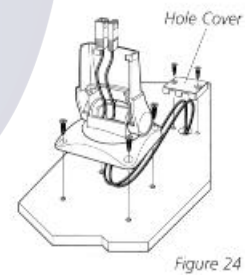
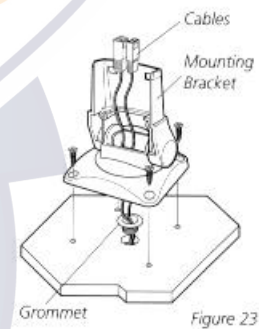
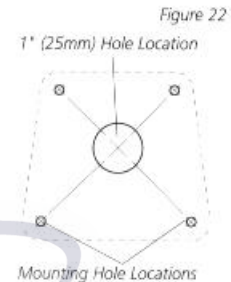



***Optional: If the cables pass outside the mounting bracket, install the hole cover over the hole and fasten in place using the two #8 x 7/8" (22mm) wood screws (Figure 24).***



# INSTALLATION

## CONTROL HEAD INSTALLATION

### Step Five - Assembling the Connector Holder

1. Insert the cable connectors into the connector holder. The cable connectors are labeled, and there are corresponding labels on the connector holder (Figure 26). The slots for the connectors are keyed to prevent reverse installation, so do not force the connector into the holder.
2. Carefully pull the excess cable from beneath the mounting surface so the connector holder aligns with the mounting holes on the front of the mounting bracket (Figure 27).
3. Snap the support plate to the rear of the connector holder (Figure 28).
4. Insert the connector holder into place and use the two #6-32 x  $\frac{3}{4}$ " (9mm) screws to fasten it to the mounting bracket (Figure 28).
5. Install the control head by sliding it onto the mounting bracket until it is fully seated. To remove the unit simply depress the latch on the rear of the unit and lift (Figure 29).

**Your Humminbird is now ready for operation.**

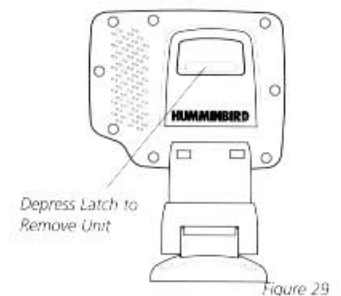
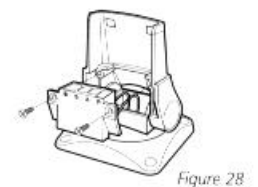
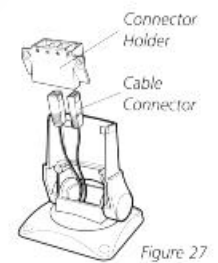
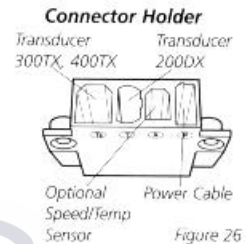

# INSTALLATION

## TEST THE INSTALLATION

### TEST THE INSTALLATION

Testing should be performed with the boat in the water, however you can initially confirm basic operation with the boat trailered.

Press POWER once to turn the unit on. There will be an audible chirp when any button is pressed to confirm the button press. If the unit does not power-up, ensure the unit is fully seated on the mount and that power is available.

The first screen provides four options: Start-up, Options, Simulator, and Diagnostic. A message at the bottom of the screen indicates the transducer connection. If no transducer is detected (or one is not connected), the message will indicate this and the unit will go into simulator after the initial screen times out.

**Note: the transducer must be submerged in water for reliable transducer detection.**

If a transducer is detected, the unit will enter "Start Up" or normal operation unless you choose another option. If you do not press any button before the timer reaches "0", the normal operation screen is displayed. If the boat is in water, sonar data appears.

If the bottom is visible on screen with a digital depth readout, the unit is working properly. Ensure the boat is in water greater than 2' but less than the depth capability of the unit and the transducer is fully submerged. Remember the sonar signal cannot pass through air.

If the unit is working properly gradually increase the boat speed to test high-speed performance. If the unit-functions well at low speeds but begins to skip or miss the bottom at higher speeds, the transducer requires adjustment. Refer to the appropriate transducer installation section for more detail.

**Note: it is often necessary to make several incremental transducer adjustments before optimum high-speed performance is achieved.**

Important: For Transom Mount transducer installations, install the third mounting screw after the final transducer adjustments.



## USING THE WIDE W

The Wide W is easy to use. Simply press the POWER button, and the unit will automatically locate the bottom. Adjust the depth range and sensitivity to an appropriate level, and draw a picture of the terrain beneath your boat. If POWER is the only button you press, you will benefit from the advanced automatic bottom tracking capability of the unit. However, if you choose to experiment with the many features and controls the Wide W offers, you can customize the presentation of information to suit your particular needs. The Wide W offers a wide variety of settings and types of display, to satisfy any sonar need.

## SIMULATOR OPERATION

The Wide W contains a simulator which allows you to use the unit as if you were on the water. This simulator is invaluable for learning how to operate the many features of the Wide W unit.

With the unit turned off, press and hold POWER until you hear a continuous chirp. This initiates the simulator operation. Your Wide W will simulate all functions as if you were actually on the water.

To exit the simulator, press POWER to turn the unit off. Pressing POWER again will power-up the unit for normal operation.

When in simulator operation, the Wide W unit will respond to control inputs as if it were in actual operation, so feel free to experiment with the many features and functions to customize the Wide W unit to your particular application.

## WHAT YOU SEE ON SCREEN

The first thing you may notice about the Wide W unit is the high-resolution screen LCD display. The LCD display uses super-twist technology, for maximum viewability and is ruggedized for tough shock and vibration endurance. The display can operate at temperatures more extreme than you are likely to encounter.

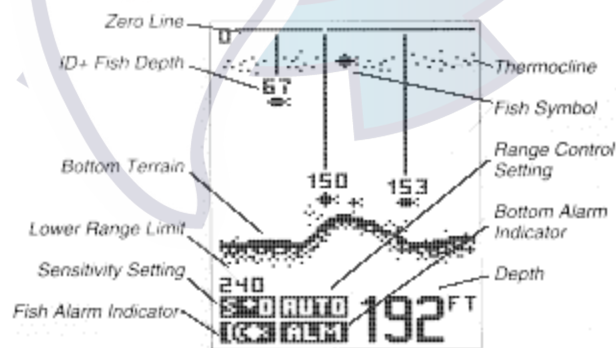

There are three basic screen layouts for the Wide W. Figure A shows the default screen layout which does not include temperature and speed readings. If you have purchased the temperature and speed accessory and it is installed, the screen layout will be slightly different as shown in Figure B.

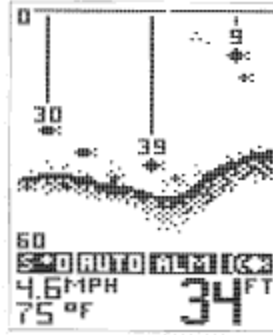

Figure B

Later, you will learn of another feature called “advanced operation”. This feature uses yet another screen layout as shown in Figure C which maximizes the display for the terrain and target presentation.

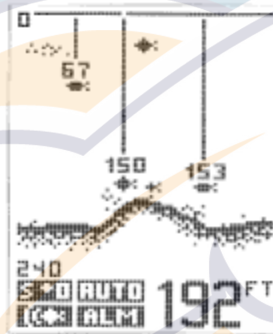

Figure A

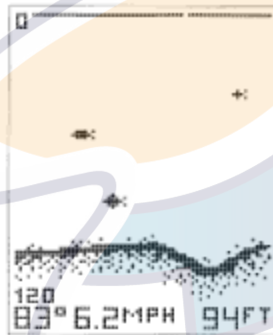

Figure C

The number of vertical pixels (picture elements or dots) in a given depth range determines the display resolution, or ability to differentiate targets close to the bottom or other targets. The Wide W is capable of distinguishing between targets only 6 inches apart, and show fish within 6 inches of the bottom.

On all screens the horizontal line at the top of the display is the “Zero” line. The “Zero” line will always have a gap which moves as the screen updates. This gap lets you know that the display is updating even if the bottom terrain remains the same or is not visible on the selected depth range. The farthest right column of information is the most recent information, and it shows what is directly under your boat.

At power-up, the Wide W locates the bottom and adjusts the depth range to a setting most appropriate for that depth. The bottom will be usually shown about 2/3 of the way down the display. The Structure ID depiction of the bottom will vary in appearance depending on the bottom terrain. If the bottom is very hard and smooth, the bottom depiction will be narrow and dense. If

the bottom is mud or soft sand, the bottom depiction will be thick and less dense. This indicates that much of the sonar signal is absorbed by the soft bottom. If the bottom is rugged and varying, such as a rocky bottom, the depiction will be textured and vary in density. Structure, such as submerged trees or brush, or other objects are clearly displayed above the solid bottom return, in varying degrees of pixelization. This bottom depiction is useful in locating structure, by comparing relative density as well as depth.

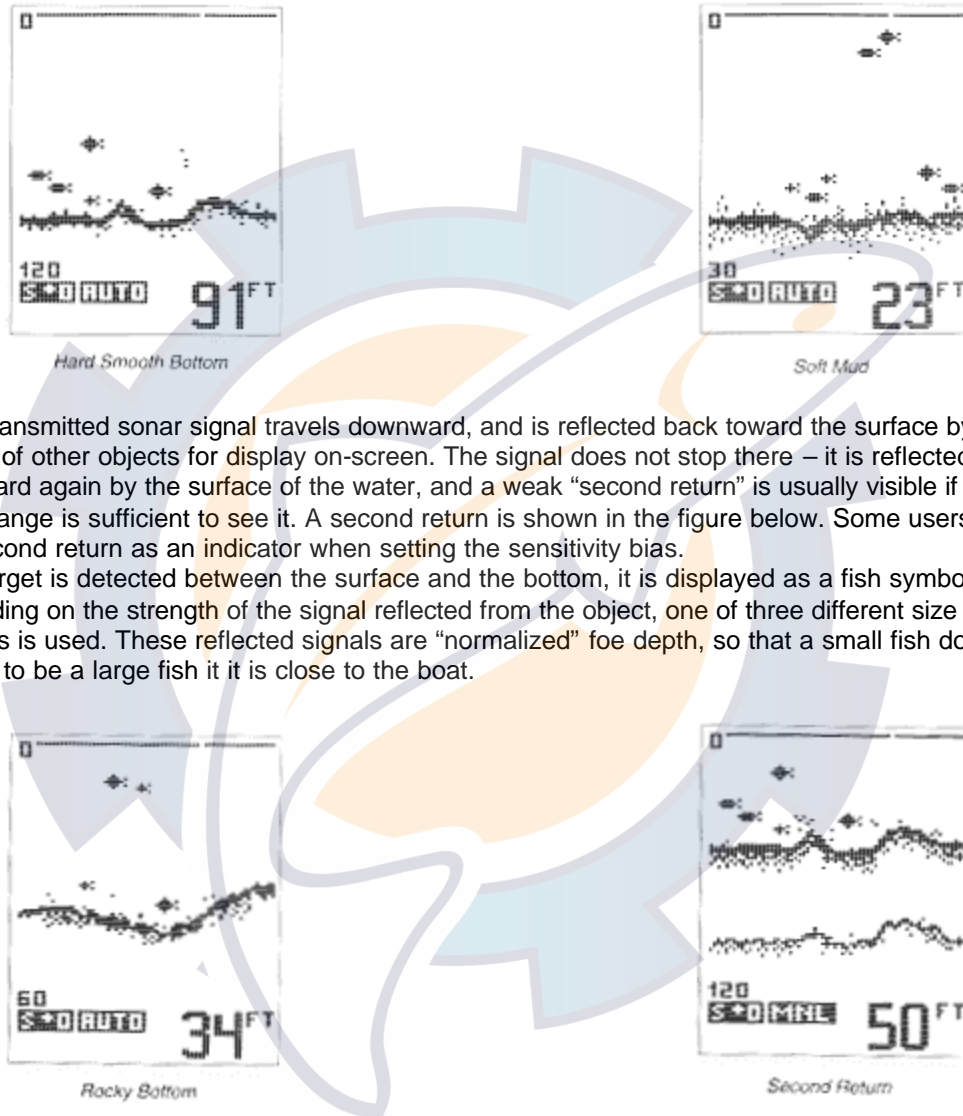

The transmitted sonar signal travels downward, and is reflected back toward the surface by the bottom of other objects for display on-screen. The signal does not stop there – it is reflected downward again by the surface of the water, and a weak “second return” is usually visible if the depth range is sufficient to see it. A second return is shown in the figure below. Some users use this second return as an indicator when setting the sensitivity bias.

If a target is detected between the surface and the bottom, it is displayed as a fish symbol. Depending on the strength of the signal reflected from the object, one of three different size symbols is used. These reflected signals are “normalized” for depth, so that a small fish does not appear to be a large fish if it is close to the boat.

Since some species of fish tend to be better reflectors of sonar than others, the strength of return is not always an accurate indicator of fish size, however, typically the larger the fish, the larger the signal return.

## CONTROL FUNCTIONS

The Wide W unit uses only seven buttons to control all functions. The controls are “divided into two groups: POWER, STOP, and LIGHT are one group, and the Menu System controls are the other group. When any button is pressed, an audible “chirp” will verify the control input.



POWER, as previously discussed, powers the Wide W for normal operation. Also, if the unit is powered off, press and hold POWER until you hear a continuous “chirp” to enable simulator operation, as discussed in “Simulator Operation”. Pressing POWER when the unit is in normal or simulator operation will power the unit off.

STOP freezes the display to allow closer study. Pressing STOP again will resume normal operation. Also if a menu is on-screen until STOP is pressed again.

LIGHT enables a two-level display back light. Pressing once will turn the light on low, pressing a second time will increase the back light to the high setting, and pressing a third time will turn the back light off.

The four remaining buttons work together to control the Menu System- an array of menu controlled functions.

Menu brings a menu on-screen for adjustment, or if a menu is already present, the next menu in sequence will appear. Menus will go off-screen and normal operation will resume after a short period of time. If you wish to keep the menu on-screen for an extended period of time, press STOP.

UP arrow selects the next larger or next sequential adjustment within the menu. Holding an Arrow button down will cause the unit to continue to make the adjustment, until a limit is reached, and the limit alarm sounds.

DOWN arrow selects the next smaller adjustment within the menu.

ENTER is used to toggle other menu options on and off.

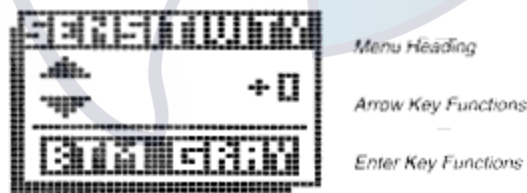

All menus use the same general layout as shown in the sample men at the right. The heading of the menu is at the top. The area in the center is controlled by the UP and DOWN arrows, and the area under the horizontal line is controlled by the ENTER button. Not all menus are affected by all controls, but the layout is the same regardless. Pressing MENU repeatedly will sequentially display all available menus.

## MENU FUNCTIONS

The following section explains each menu in detail, and how these adjustments can be used to obtain the maximum information from the sonar returns.

## SENSITIVITY

As the Wide W receives returned signals, the sensitivity of the receiver as adjusted automatically based on a number of factors such as the depth of the water, and the signal clarity. In murky water, full of debris, The Wide W will select a lower sensitivity setting. In Clear water, where there is little debris to deflect the sonar signal, the sensitivity is set higher.



The Sensitivity menu allows you to “bias” this automatic setting up or down based on personal preference.

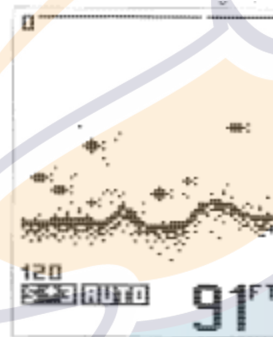

*Sensitivity bias of +3*

You can select a bias of +5 to -5, for 11 different bias settings. A bias setting of “0” has no effect on the automatic function. A +3 setting selects a sensitivity setting three steps higher than the unit would normally select, so even the smallest returns are displayed on the screen.

A setting of -2 sets the sensitivity two steps below what the unit would normally select, so only the largest targets or other returns are displayed.



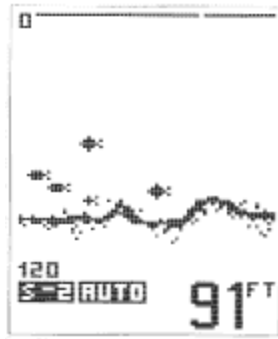

Sensitivity bias of -2

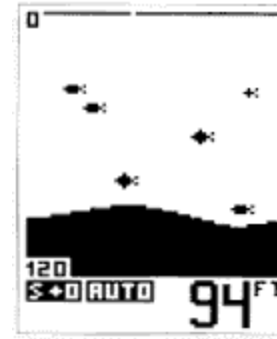

Blackened Bottom

Another use of the Sensitivity menu is to select the bottom representation. The Wide W normally displays a variable Structure ID bottom, which can allow experienced users to determine the texture or relative hardness of the bottom. For simplicity, you can select a black bottom using the ENTER button. This blackens in the display below the bottom for easiest recognition of the bottom location, even from a great distance.

## RANGE

The Wide W adjusts the depth range automatically, so the bottom return is displayed at the bottom 1/3 of the display. This leaves the top 2/3 to display anything between the surface and the bottom. As your boat moves over deeper or shallower water, the unit adjusts the depth range of the display to keep the bottom return in the same general area on the screen.

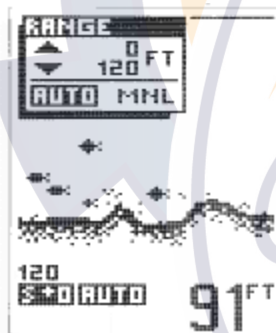

Auto Range Control Indicator



Manual Range Control Indicator

However, you may choose to control this range adjustment manually. By pressing ENTER, you can select manual operation, meaning the unit will no longer adjust the depth range automatically. The depth range selected is controlled by the UP and DOWN arrow buttons. Ranges of 0-15 feet, 30 feet, 60 feet, 120 feet, 180 feet, 240 feet, 360 feet, 480 feet, & 600 feet can be selected. An onscreen icon indicates whether the unit is in "Auto" or "MNL" (manual) range control.

If you alter the depth range, Manual operation is automatically selected. This feature is valuable if you are only interested in targets near the surface. The Wide W will always display the digital depth of the water, regardless of whether the bottom is shown on the selected depth range.

## ZOOM

Another form of range control is Zoom. Zoom allows selection of various ranges for full screen viewing, not necessarily including the surface. By using the display to view a smaller area, the

effective display resolution is increased, and the units ability to separate targets close together is enabled.

The zoom range is determined by the depth range in use when Zoom is enabled. IN shallow water, when the 15 foot or 39 foot depth is used, the zoom range will be 7-1/2 feet. If the 60 foot or 120 foot depth range is in use, the zoom range will be 15 feet, if a 180 foot - 480 depth range is used, the zoom range will be 60 feet.



To enable Zoom, adjust the depth of the zoom range first using the UP and DOWN arrow buttons until the upper and lower limit numbers correspond with the range you wish to view, then enable Zoom using the ENTER button.

Once you are in zoom, you may still adjust the depth of the zoom range by using the UP and DOWN arrow buttons. The Zoom menu will not appear when an adjustment is made unless MENU is pressed. The digital depth readout will continue to track the bottom even when Zoom is enabled.



Zoomed

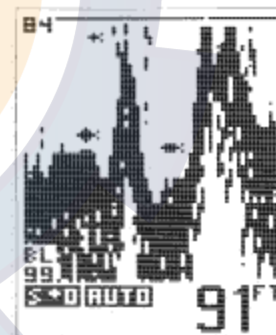

Bottom Lock

Bottom Lock is a function of zoom, except the depth adjustment is controlled automatically to view the area immediately above the bottom. This is especially useful if you are looking for structure or minor variations in terrain in areas of relatively flat bottom terrain. To enable Bottom Lock, Press ENTER until the "BL" is highlighted. The zoom range will be controlled by the current depth range, as in Zoom, and will be indicated on the Zoom menu.

## BOTTOM ALARM

The Wide W contains an audible alarm to warn you of shallow water depths. This alarm is adjustable from 2 feet to 99 feet of depth. To enable the alarm, simply adjust the alarm depth using the UP and DOWN arrow buttons, and press ENTER. Whenever the depth of the water

beneath your boat is equal to or less than the selected alarm depth, a continuous alarm will sound.

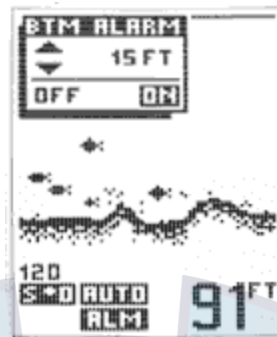

Bottom Alarm "On" Indicator

To disable the alarm, either move to deeper water, or select the Bottom Alarm menu, and press ENTER to turn the alarm off.

## FISH ALARM

The Fish Alarm alerts you to the presence of fish, or other targets not attached to the bottom, in the water beneath your boat. The Fish Alarm has 3 different settings which correspond to the 3 different size fish targets shown on-screen.



Fish Alarm "On" Indicator

To enable Fish Alarm, use the UP and DOWN arrow buttons to adjust the size return you want to be alerted to: large fish only, large and medium size fish, or all fish. Then press ENTER to enable the alarm.

Remember that it is impossible for sonar to determine if a signal return is a fish or some other type of object or suspended debris. Any object not connected to the bottom is normally a fish and is portrayed as a fish symbol. The strength of the reflected sonar signal from a target is a good indicator of the size of the target, and the fish symbol displayed represents the strength of the signal reflected from it.

## ID

ID is the automatic identification of target returns based on the strength of the returned signal and other factors. Three options are available: ID "On" displays targets as one of three different size fish symbols.

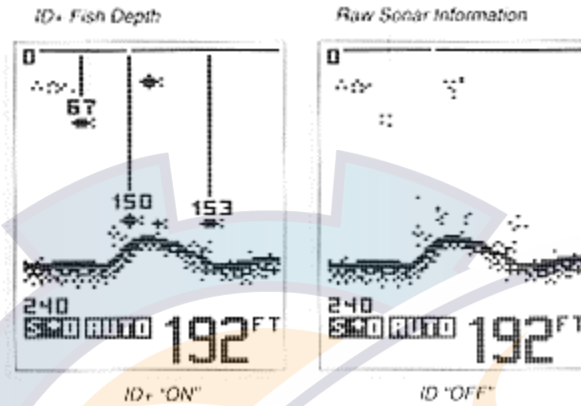

"ID+", the default setting, provides more information about the location of the target by attaching depth "strings" showing the digital depth of the target. When there are numerous targets on-screen, not every target depth is shown, to avoid excessive clutter on-screen.

ID "Off" disables the units interpretation of targets and displays the "raw" sonar information as it is received. Advanced users may prefer this type of presentation, so they can make their own interpretation from the information displayed.

## TRIPLOG

Triplog provides a time/distance calculation, based on input from the optional speed accessory. The timer is started when the unit is first powered, and distance information is collected to provide elapsed distance since power-up, and the average speed. To enable the Triplog display, press ENTER.



The Triplog can be reset at any time by pressing STOP. Press ENTER to return to the normal screen.



Note: The optional Temp/ Speed accessory must be connected for Triplog to work.

## SYSTEM OPTIONS

The System Options menu allows the adjustment of several features. These adjustments are usually made initially, and rarely thereafter. To make these adjustments, first enter the System Options full screen menu with the ENTER key. Then press MENU to choose the category for adjustment, the UP and DOWN arrow buttons to adjust the setting, and the ENTER key to return to the normal screen when you have finished.

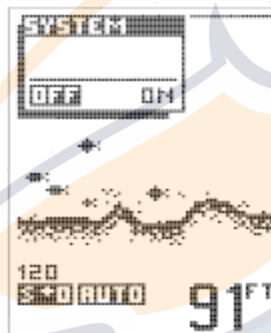

Scroll Rate controls the rate of update of the display. There are five rate settings available. The default setting is rate 4- you may speed up or slow down the update rate to match your personal preference.

To present the most accurate representation of the terrain beneath your boat, the scroll rate of the display should be approximately synchronized to the speed of the boat. If your boat is stationary or moving slowly, select a slower scroll rate, and if you typically operate the boat at high speeds, use a faster scroll rate.

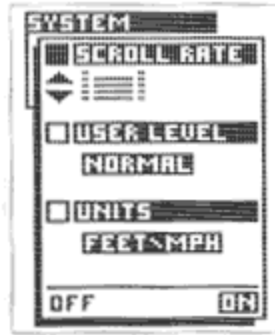

User Level is used to select Normal or Advanced operation. Advanced Mode performs several functions which will benefit the experienced user. Icons are not shown and numerical data is smaller to allow more of the display to be used for the picture of the bottom. Several other changes in operation occur which are designed to increase the speed of adjustments, and maximize the graphic use of the display.

Units is used to select the way in which the Wide W displays your boat speed. Two options are available, KTS and MPH. KTS displays your boat speed in knots or nautical miles per hour. MPH displays statute miles per hour. The units of measurement are always displayed on-screen.

Boat speed and water temperature features require the use of the optional temp /speed accessory, which must be purchased separately.